



9 mm x 14 mm Plastic Package SMD Oscillator, TTL / HC-MOS



ISM61 Series

Product Features:

Low Jitter, Non-PLL Based Output
 CMOS/TTL Compatible Logic Levels
 Compatible with Leadfree Processing

Applications:

Fibre Channel
 Server & Storage
 Sonet /SDH
 802.11 / Wifi
 T1/E1, T3/E3
 System Clock

Frequency	30 KHz to 150.000 MHz
Output Level HC-MOS TTL	'0' = 0.1 Vcc Max., '1' = 0.9 Vcc Min. '0' = 0.4 VDC Max., '1' = 2.4 VDC Min.
Duty Cycle	Specify 50% ±10% or ±5% See Table in Part Number Guide
Rise / Fall Time	5 nS Max. @ Vcc = +3.3 VDC, 10 nS Max. @ Vcc = +5 VDC ***
Output Load	Fo < 50 MHz = 10 TTL, Fo > 50 MHz = 5 LSTTL See Table in Part Number Guide
Frequency Stability	See Frequency Stability Table (Includes room temperature tolerance and stability over operating temperature)
Start-up Time	10 mS Max.
Enable / Disable Time	100 nS Max. N.C. or ≥ 70% Vdd = Enable. ≤ 30% Vdd = Disable.
Supply Voltage	See Input Voltage Table, tolerance ±5 %
Current	70 mA Max. ***
Operating	See Operating Temperature Table in Part Number Guide
Storage	-55° C to +125° C
Jitter: RMS(1sigma) 1 MHz-75 MHz 76 MHz-150 MHz	5 pS RMS (1 sigma) Max. accumulated jitter (20K adjacent periods) 3 pS RMS (1 sigma) Max. accumulated jitter (20K adjacent periods)
Max Integrated 1 MHz-75 MHz 76 MHz-150 MHz	1.5 pS RMS (1 sigma -12KHz to 20MHz) 1 pS RMS (1 sigma -12KHz to 20MHz)
Max Total Jitter 1 MHz-75 MHz 76 MHz-150 MHz	50 pS p-p (100K adjacent periods) 30 pS p-p (100K adjacent periods)

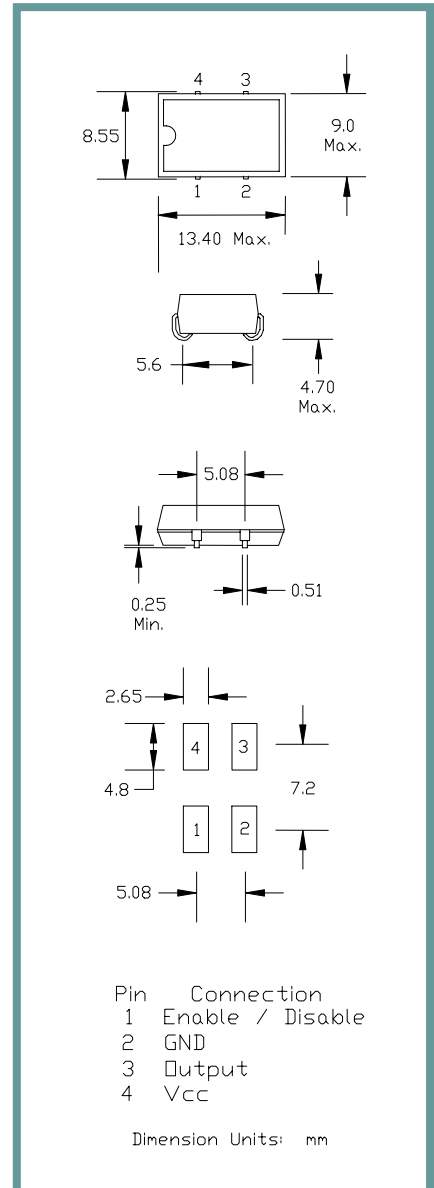

Part Number Guide		Sample Part Number: ISM61 - 3251BH - 20.000		Stability (in ppm)	Enable / Disable	Frequency	
Package	Input Voltage	Operating Temperature	Symmetry (Duty Cycle)	Output			
ISM61 -	5 = 5.0 V	1 = 0° C to +70° C	5 = 45 / 55 Max.	1 = 10TTL / 15 pF HC-MOS	**E = ±10	H = Enable	- 20.000 MHz
	3 = 3.3 V	6 = -10° C to +70° C	6 = 40 / 60 Max.	6 = 30 pF	**D = ±15	O = N/C	
	7 = 3.0 V	3 = -20° C to +70° C		5 = 50 pF HC-MOS (<40 MHz)	**F = ±20		
	2 = 2.7 V	4 = -30° C to +75° C			**A = ±25		
	6 = 2.5 V	2 = -40° C to +85° C			B = ±50		
	1 = 1.8 V*				C = ±100		

NOTE: A 0.01 µF bypass capacitor is recommended between Vcc (pin 4) and GND (pin 2) to minimize power supply noise.
 * Not available at all frequencies. ** Not available for all temperature ranges. *** Frequency, supply, and load related parameters.



9 mm x 14 mm Plastic Package SMD Oscillator, TTL / HC-MOS

ISM61 Series

Pb Free Solder Reflow Profile

Typical Application

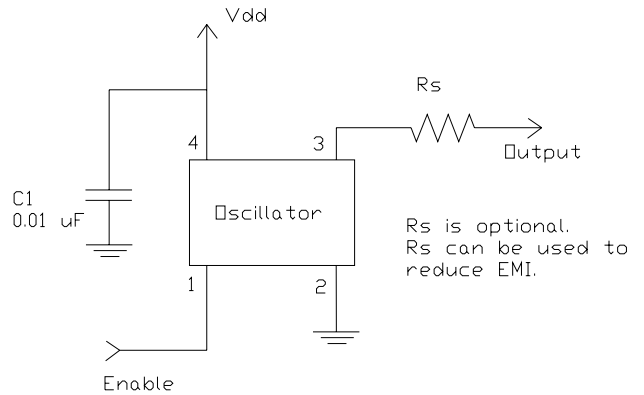
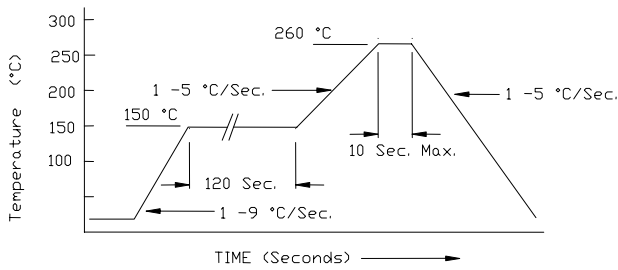

*Units are backward compatible with 240C reflow processes

Package Information

MSL = 2a
Termination = e2

Tape and Reel Information

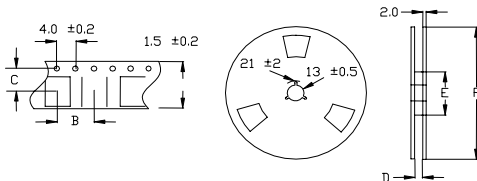

Quantity per Reel	1000
A	24 +/- .3
B	12 +/- .2
C	11.5 +/- .2
D	25 +/- 1.5
E	80 / 100
F	180

Environmental Specifications

Thermal Shock	MIL-STD-883, Method 1011, Condition A
Moisture Resistance	MIL-STD-883, Method 1004
Mechanical Shock	MIL-STD-883, Method 2002, Condition B
Mechanical Vibration	MIL-STD-883, Method 2007, Condition A
Resistance to Soldering Heat	J-STD-020C, Table 5-2 Pb-free devices (except 2 cycles max)
Hazardous Substance	Pb-Free / RoHS / Green Compliant
Solderability	JESD22-B102-D Method 2 (Preconditioning E)
Terminal Strength	MIL-STD-883, Method 2004, Test Condition D
Gross Leak	MIL-STD-883, Method 1014, Condition C
Fine Leak	MIL-STD-883, Method 1014, Condition A2, R1=2x10 ⁻⁸ atm cc/s
Solvent Resistance	MIL-STD-202, Method 215

Marking

Line 1: ILSI and Date Code (YWW)
Line 2: Frequency