



SMD Crystal, AT cut
4 Pad Ceramic Package, 3.5 mm x 6 mm

ILCX08 Series

Frequency Range (MHz)	8 MHz to 40 MHz (Fundamental)	36 MHz to 100 MHz (3 rd Overtone)
Equivalent Series Resistance (Ω Max.)	60	60
Shunt Capacitance (C0)	7 pF Max.	
Frequency Tolerance	± 30 ppm Standard (see Appendix A for more options)	
Frequency Stability over Temperature	± 50 ppm Standard (see Appendix A for more options)	
Crystal Cut	AT Cut	
Load Capacitance	18 pF Standard (see Appendix A for more options)	
Drive Level	500 uW Max.	
Aging	± 5 ppm Max. / Year Standard	
Temperature		
Operating	0° C to +70° C Standard (see Appendix A for more options)	
Storage	-40° C to +85° C Standard	
Environmental / Tape and Reel	See Appendix B for Environmental information, Appendix C for Tape and Reel information	
Package Information	MSL = N.A., Termination = e4	

Recommended pad layout

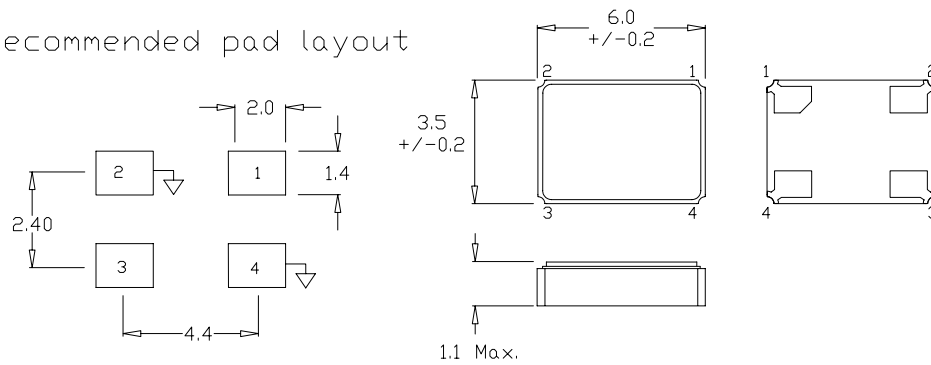

Connection Diagram

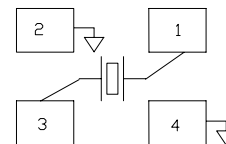

Dimension Units: mm

Part Number Guide		Sample Part Number: ILCX08 - FB1F18 - 20.000				
Package	Frequency Tolerance	Frequency Stability	Operating Temp.	Mode	Load Capacitance	Frequency
ILCX08 -	F = ± 30 ppm	B = ± 50 ppm	1 = 0° C to +70° C	F = Fundamental	18 = 18 pF	- 20.000 MHz